

Packaging Information

• Reel Dimension

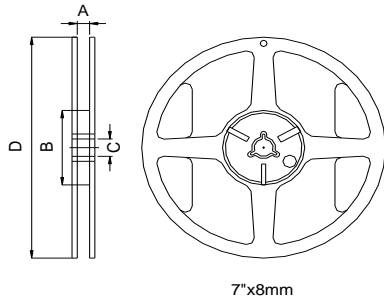

Type	A(mm)	B(mm)	C(mm)	D(mm)
7"x8mm	8.4+1.5/-0.0	60±1.0	13+0.5/-0.2	178±2.0

• Tape Dimension / 8mm

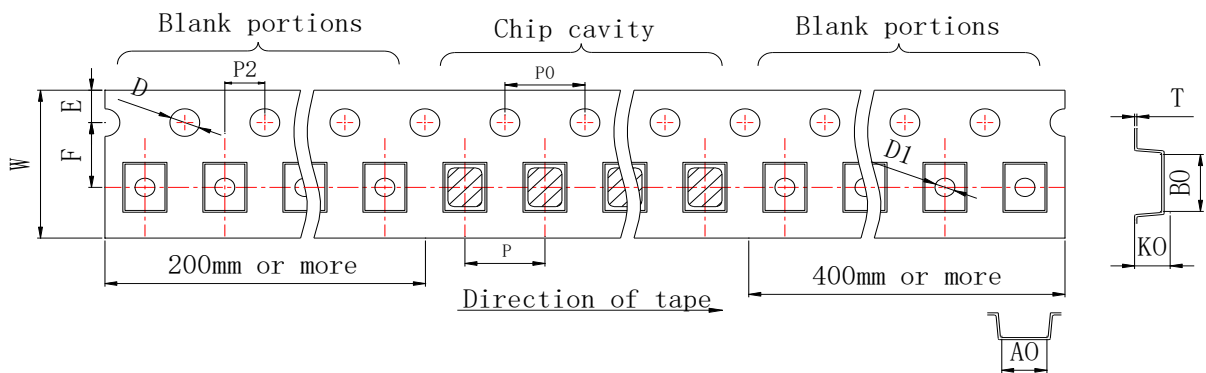

A0(mm)	B0(mm)	K0(mm)	W(mm)	P(mm)	P0(mm)	P2(mm)	E(mm)	F(mm)	T(mm)	D(mm)	D1(mm)
1.5±0.1	2.3±0.1	1.2±0.1	8.0±0.1	4.0±0.1	4.0±0.1	2.0±0.1	1.75±0.1	3.5±0.1	0.25±0.05	1.5+0.1/-0.0	1.0±0.1

• Packaging Quantity

Size	Reel
JRIM 201210HL	3000

• Tearing Off Force

The force for tearing off cover tape is 10 to 100 grams in the arrow direction under the following conditions (referenced ANSI/EIA-481-D-2008 of 4.11 standard).

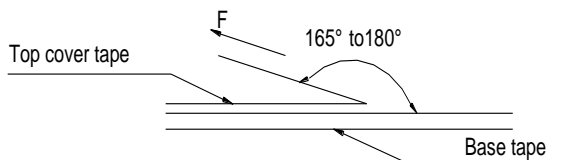

Tearing Speed mm	Room Temp. (°C)	Room Humidity (%)	Room atm (hPa)
300±10%	5~35	45~85	860~1060

■ Application Notice

- Storage Conditions(component level)

To maintain the solderability of terminal electrodes:

1. Products meet IPC/JEDEC J-STD-020E standard-MSL, level 1.
2. Temperature and humidity conditions: Less than 40°C and 60% RH.
3. Recommended products should be used within 12 months form the time of delivery.
4. The packaging material should be kept where no chlorine or sulfur exists in the air.

- Transportation

1. Products should be handled with care to avoid damage or contamination from perspiration and skin oils.
2. The use of tweezers or vacuum pick up is strongly recommended for individual components.
3. Bulk handling should ensure that abrasion and mechanical shock are minimized.